



TECHNICAL SOLUTIONS
industrial technology

Solar PV Systems

Engineering, Procurement, Commissioning & Auditing Solutions



Fast implementation



International procurement



Project-specific mounting systems

Technical Solutions LLC





Solar PV Systems

From solar opportunity to energised asset



**Fast
implementation**



**International
procurement channels**



**Project-specific
mounting systems**



Built for Libya: heat, dust, wind, logistics, and grid integration



TECHNICAL SOLUTIONS
industrial technology

Technical Solutions LLC

Local strength, global technology access



Energy



Telecommunications



Industrial Technology



Integrated solar delivery



Engineering



Procurement



Implementation



Training



Support



Commissioning



Auditing



Single accountable project partner



One Partner for the Solar Asset Lifecycle

From project idea to verified performance

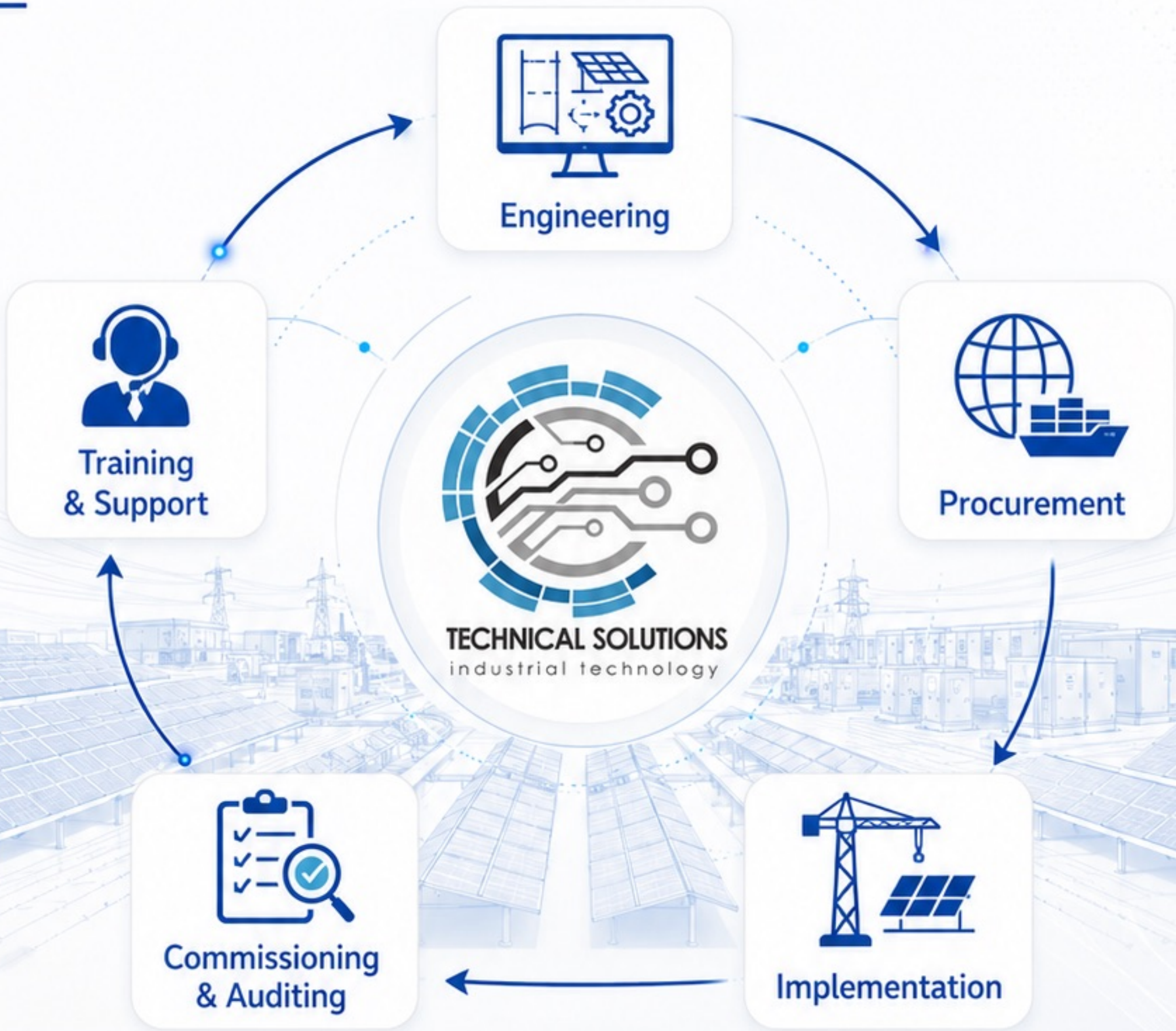

Installed



documented



tested



monitored



ready to operate



Fast-Track Implementation Model

Compress the schedule without reducing control

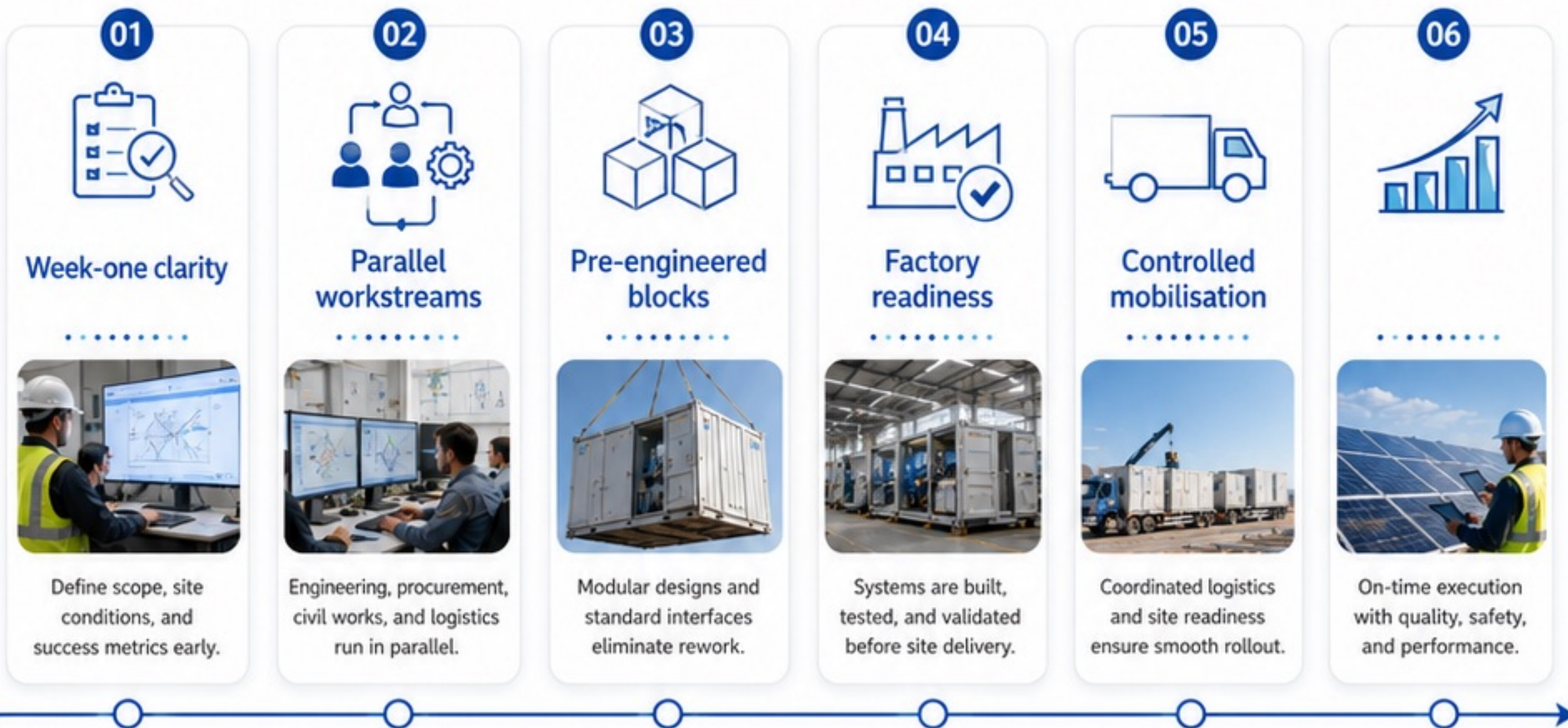

Speed through discipline, not shortcuts







Engineering Built Around the Site

Design decisions that protect performance





 **Site & resource assessment**
— 

 **PV layout & energy yield**
— 

 **Civil & structural design**
— 

 **Electrical design**
— 

 **Build-ready documentation**
— 



Reliability starts before procurement



International Procurement Channels

Tiered sourcing for speed, quality, and cost control



Vendor qualification



Rigorous assessment of manufacturers to ensure reliability, compliance, and financial stability.



Multi-route sourcing



Diversified global network reduces risk, shortens lead times, and improves negotiating power.



Project-specific purchasing



Materials and quantities aligned precisely with design, schedule, and performance targets.



Logistics control



End-to-end logistics management for timely, safe delivery to site with full visibility.



Quality assurance



Factory audits, inspections, and testing to ensure every component meets our quality standards.



Modules



inverters



mounting



protection



monitoring



MV equipment



Project-Specific Mounting Systems

A mounting decision matrix for faster execution

	Fixed-Tilt Ground Mount	High-Density Low-Tilt	Solar Trackers	Rooftop Mount	Carport Mount	Agri-PV Systems	Floating PV	Foundations & Structures
Land use	●●○○○	●●●●○	●●●○○	●○○○○	●●○○○	●●●○○	●●○○○	—
Installation speed	●●●●○	●●●●○	●●○○○	●●●○○	●●●○○	●●○○○	●○○○○	●●○○○
Structural risk	●●●●○	●●●○○	●●○○○	●●●●○	●●●○○	●●●○○	●●○○○	●●●●○
Energy yield	●●●○○	●●●○○	●●●●●	●●○○○	●●●○○	●●●○○	●●●○○	—
Operations access	●●●●○	●●●○○	●●○○○	●●○○○	●●●●○	●●●○○	●●●○○	●●●●○

Site-first engineering

Climate & soil adapted

Standards & safety aligned

Performance focused

Low O&M by design



The structure must fit the site — not the opposite



High-Density Low-Tilt Ground Mount

More power from constrained land



Compact. Efficient. Scalable.

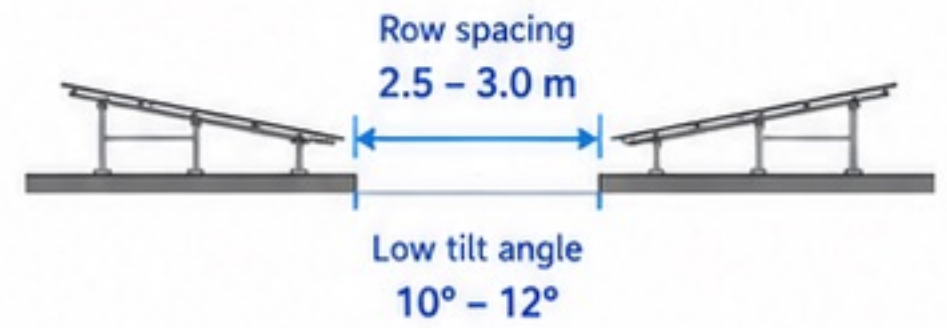

East-West Configuration



Compact row spacing

Tight row spacing maximizes installed capacity per hectare without compromising performance.



Low-profile geometry

Low tilt minimizes height, reduces wind loads, and improves structural efficiency.



Fast repeatable installation

Pre-engineered components and repeatable blocks reduce on-site time and cost.



Designed for desert sites, industrial campuses, and land-limited projects



More power



Less land



Faster deployment



Fixed-Tilt Ground-Mount Systems

Robust, simple, and fast to build



Single-post or
dual-post tables



Preassembled
components



Terrain
adaptability

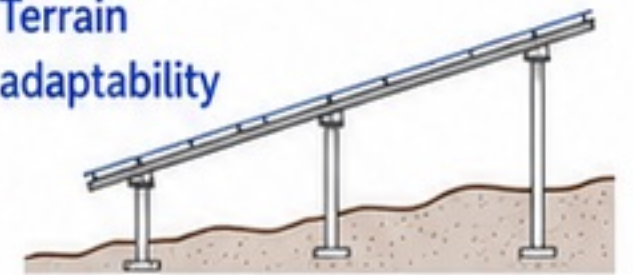

Low-maintenance
operation



Engineered
for durability



Wind and
corrosion
resistant



Fast,
repeatable
installation



Proven
performance
at scale



A dependable path to a
reliable solar asset











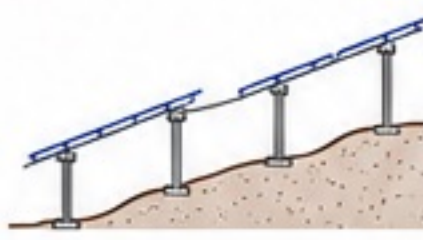

Solar Tracking Systems

Higher yield where the site and budget support it

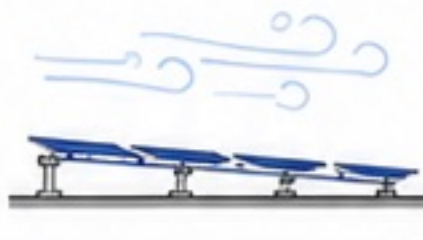

-  **Single-axis tracking** 
-  **Backtracking control** 
-  **Terrain-following options** 
-  **Wind stow strategy** 
-  **SCADA integration and tracker commissioning** 



-  **UP TO 20-30% MORE ENERGY YIELD**
-  **MAXIMISE PRODUCTION THROUGHOUT THE DAY**
-  **ENGINEERED FOR RELIABILITY IN HARSH CONDITIONS**
-  **PROVEN TECHNOLOGY WITH GLOBAL INSTALLATIONS**
-  **SMART CONTROL FOR OPTIMAL PERFORMANCE**
-  **LOCAL SUPPORT AND LONG-TERM SERVICE**

 **Yield gains must be balanced with complexity and maintenance**



Foundation Technologies

The fastest structure starts below ground



Structural stability
in all soil conditions



Faster installation
less site disruption



Optimized for
performance
and durability



Lower carbon
with minimal
concrete use

1 Driven piles



Steel piles driven into the ground using hydraulic hammers for high capacity and minimal vibration.

2 Ground screws



Screw into the ground with minimal equipment. Ideal for fast installation and reduced soil impact.

3 Helical piles



Engineered helix plates provide high uplift and lateral resistance in challenging soil conditions.

4 Drill-and-drive systems



Pre-drill the bore and drive the pile for improved precision and performance in hard or rocky soils.

5 Ballasted foundations



Concrete ballast blocks provide stability without penetrating the ground. Ideal for softer soils.



Geotechnical review protects the schedule

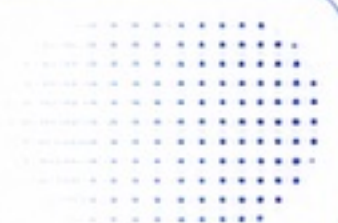



Rooftop & Building-Mounted PV

Fast solar where the load already exists



From roof to usable power

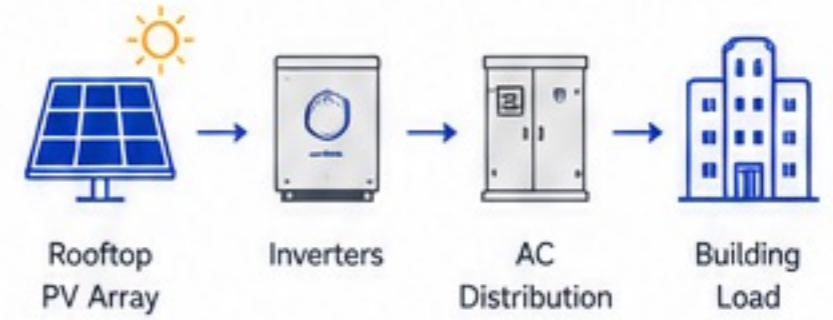

- ✔ Disconnects & protection
- ✔ Monitoring & performance
- ✔ Grid connection (where applicable)



Lower energy cost

Generate clean power on-site and reduce utility expenses.



Sustainable operations

Cut emissions and support corporate ESG goals.



Minimal disruption

Engineered for fast installation with safe site access.



Scalable solutions

From small rooftops to large industrial facilities.

Flat-roof ballasted systems

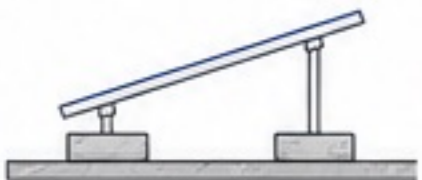

No roof penetrations. Protects waterproofing and distributes loads evenly.

East-West roof layouts

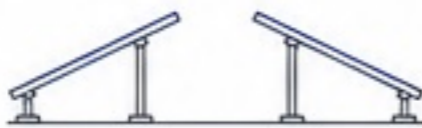

Higher energy yield throughout the day with better roof utilization.

Standing-seam clamps



Secure attachment without penetrations. Preserves roof integrity and warranty.

Rail-less metal roof systems



Fewer components, faster installation, lower cost with high reliability.

Facade PV and lightweight modules

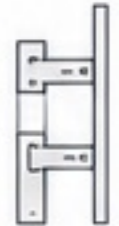

Turn building surfaces into energy assets with aesthetic, lightweight solutions.



Respect roof load, waterproofing, wind uplift, and access





Carports, Agri-PV & Floating Solar

Turn underused space into productive energy infrastructure

01 Solar carports



- ✓ Vehicle shading
- ✓ On-site generation
- ✓ Additional revenue
- ✓ Clean and durable



02 Agri-PV



- ✓ Land sharing
- ✓ Crop protection
- ✓ Improved yields
- ✓ Sustainable farming



03 Floating PV



- ✓ Water-surface generation
- ✓ Reduced evaporation
- ✓ Efficient cooling
- ✓ Minimal land use

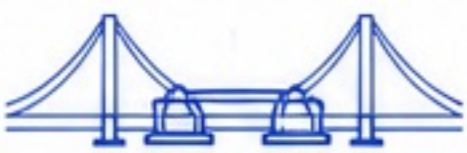

Flexible
cable-span structures



Shade



Land sharing



Water-surface
generation



Special sites



Modular Inverters & Grid Connection

Containerised systems for speed and stability



Pre-integrated inverter stations

Fully integrated, factory-tested inverter solutions in ISO containers for rapid deployment.



Grid compatibility

Compliant with EU and international grid codes for seamless utility integration.



Electrical BOS

MV transformer, switchgear, protection, metering, auxiliary power, and cabling—everything you need.



Safety by design

Built-in protection, fire detection, ventilation, and access control for maximum safety.



Commissioning readiness

Pre-tested systems with documentation and FAT for fast on-site commissioning.



DC FROM PV ARRAYS



INVERTER CONVERSION



MV TRANSFORMER



TO GRID

Complete, integrated, and built for performance

INVERTERS



High-efficiency inverters with advanced MPPT and built-in protection.

MV TRANSFORMER



Step-up transformer optimized for efficiency and reliability.

MV SWITCHGEAR



Robust switchgear with protection, interlocks, and monitoring.

MONITORING SYSTEM



SCADA-ready monitoring for real-time visibility and remote control.

AUXILIARY SYSTEMS



Aux power, cooling, lighting, and HVAC for continuous operation.



From pilot installation to multi-megawatt expansion











Commissioning Services

Verify safety, operation, and handover readiness



-  **01** Pre-commissioning review
-  **02** Visual & mechanical inspection
-   **03** Electrical testing
-  **04** Inverter and grid start-up
-  **05** Handover documentation



Safety first



Standards compliance



Performance verified



Quality assured



Ready for monitoring

STRING CURRENT VERIFICATION



- Open circuit voltage
- Short circuit current
- Polarity and string mapping

IV CURVE TESTING

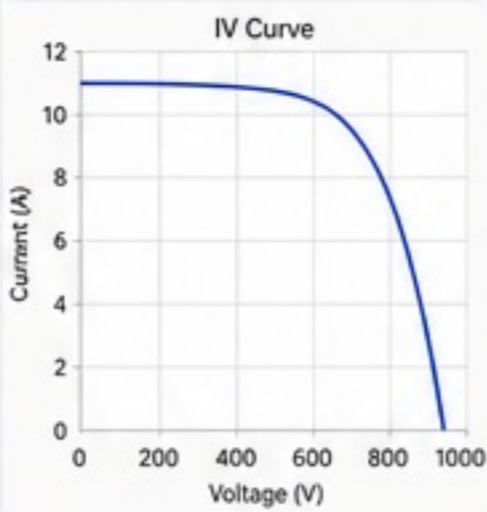

- Curve shape validation
- Performance assessment
- Module/ string comparison

INSULATION RESISTANCE TEST



- Insulation resistance (Megger)
- Conductor to ground
- Conductor to conductor

THERMAL IMAGING INSPECTION

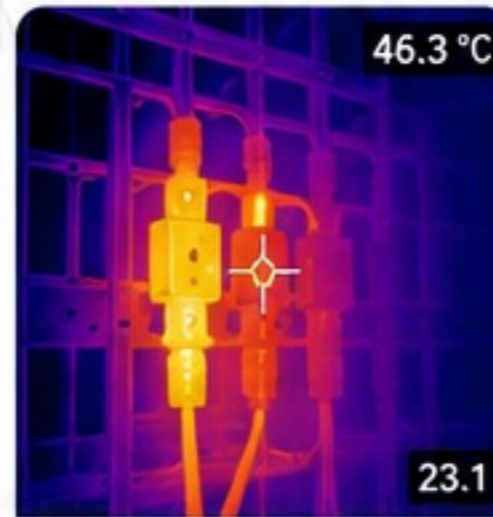

- Hotspot detection
- Connection integrity
- Preventive correction

GRID & PROTECTION VERIFICATION



- Protection settings check
- Grid synchronization
- Functional testing



Documented • tested • energised • ready for monitoring





Solar PV Auditing Solutions

Independent insight before, during, and after construction



Design audit

Review of studies, drawings, simulations, and yield assumptions.



Procurement audit

Verification of specifications, component selection, and supplier compliance.



Construction audit

On-site inspection of installation quality, materials, and workmanship.



Performance audit

Analysis of system output, PR, losses, and overall plant performance.



Safety audit

Assessment of HSE compliance, electrical safety, and access control.



Root-cause analysis

Identification of issues and corrective actions to prevent recurrence.

AERIAL & VISUAL INSPECTION



High-resolution imagery and visual inspection for physical anomalies, soiling, and layout verification.

THERMAL INSPECTION

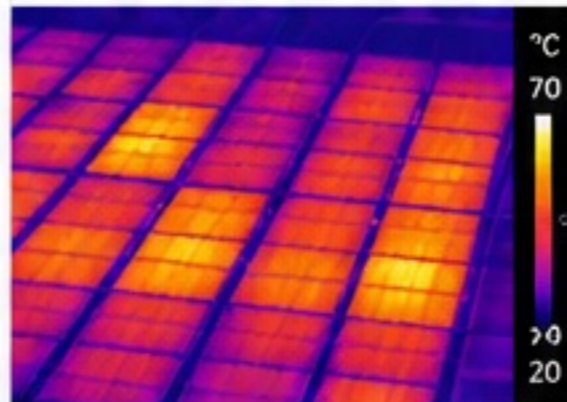

IR thermography to detect hotspots, bypass diodes, poor connections, and underperforming strings.

ELECTRICAL TESTING



IV curve, insulation resistance, string voltage/current, and continuity testing for accurate system diagnostics.

AUDIT CHECKLIST

- ✓ Documentation review
- ✓ Design and yield assessment
- ✓ Procurement and BOM verification
- ✓ Installation quality verification
- ✓ Electrical testing and measurements
- ✓ Performance and energy analysis
- ✓ Safety and compliance check
- ✓ Findings, punch list, and recommendations
- ✓ Audit report and handover

ROOT-CAUSE ANALYSIS PROCESS



TYPICAL FINDINGS WE HELP YOU PREVENT



Protect the client from avoidable technical risk





Monitoring & O&M Readiness

Keep the plant performing after handover

PLANT OVERVIEW

Plant Capacity
50.0
MWp

Current Power
37.8
MW

Today's Energy
229.4 MWh

Monthly Energy
6,842 MWh

Specific Yield
4.63 kWh/kWp

CO₂ Avoided
2,845 t

POWER & ENERGY



PLANT HEALTH

120

Inverters
Online

24

Combiner Boxes
Online

100%

Communication
OK

2

Alarms
Active

ALARM OVERVIEW

Severity	Time	Source	Description	Status
⚠	10:24	INV-045	Grid Voltage High	Active
⚠	09:47	CB-12	String Current Imbalance	Active

ENVIRONMENTAL DATA

842
W/m²

36.2
°C

4.6
m/s

28
%



- Performance monitoring**
Continuous real-time monitoring of plant performance, energy yield, and key parameters.
- Preventive maintenance**
Scheduled inspections and condition checks to prevent issues and extend equipment life.
- Corrective maintenance**
Rapid issue resolution and part replacement to minimize downtime and energy loss.
- Monthly reporting**
Detailed monthly reports with KPIs, trends, events, and performance analysis.
- Early fault detection and clear responsibilities**
Smart alerts, fault diagnostics, and defined roles ensure fast response and accountability.



Sustained performance is the real milestone





Training & Knowledge Transfer

Build local capability from day one



Outputs:



checklists



operating guides



emergency procedures



maintenance calendar

01

Level 1 —
Foundational
power training



- Electrical fundamentals
- Power systems & safety
- Tools and measurements
- Standards & regulations

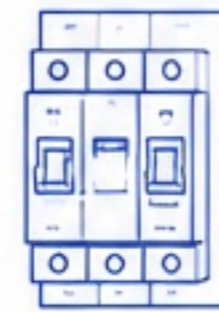
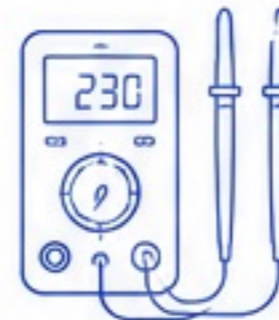

02

Level 2 —
Specialized
PV system training



- PV system components
- Inverters & protections
- System design basics
- Monitoring & performance

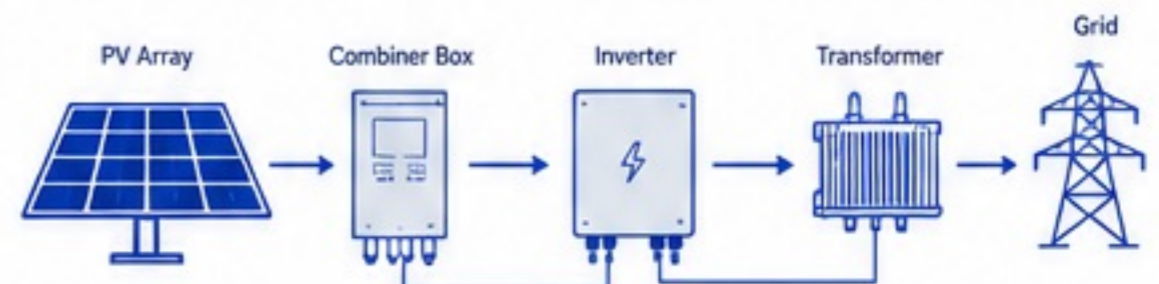

03

Level 3 —
On-site practical
instruction



- Site installation practices
- Commissioning & testing
- Fault finding & diagnostics
- O&M best practices



Practical learning



Build confidence



Hands-on skills



Better performance



Safe operations



Client teams ready for independent operation





Delivery Roadmap

A practical path from concept to audited operation





TECHNICAL SOLUTIONS
industrial technology

Power Your Next Project with Technical Solutions LLC

Fast solar implementation with engineering discipline



For new projects:
define the best
system architecture



For urgent projects:
modular equipment
and fast-track
work packages



For existing assets:
audit performance
and diagnose issues



For client teams:
structured training
and practical
handover



Move quickly
while managing technical risk



Engineering
Excellence



Fast
Implementation



Reliable
Performance



Trusted
Partnership



Long-Term
Support



TECHNICAL SOLUTIONS
industrial technology

Contact Us

Get in touch with Technical Solutions



Phone / WhatsApp:
+218-91-656-3446



Email:
m.alhouni@ttis.ly



Website:
www.ttis.ly



Location:
Benghazi, Libya



Engineering support



Project scoping



Procurement guidance



Technical consultation